

## Table of Contents

1	Cover
2	Table of Contents
3	System Features
4	System Parts
10	Typical Details
13	SSG Details
15	Infill Options
16	Entrance Details
17	Corner Details
20	Trim Details
21	Anchor Details
23	Wind Load & Deadload Charts
30	Performance



### System Features



Facades USA's 1500T Storefront System is an easy to install stick built system featuring options to meet the needs of most projects.

- Mullion Styles:
  - 4-Sided Captured
- System Dimensions:
  - 2" Sightlines
  - 4-1/2" Depth
- Infill Thicknesses:
  - 1" Thick Infill Standard
  - Glazing Adapters For 1/8" to 1-1/8" Infill
- Thermally broken design for energy performance
- Shear block construction prevents visible fasteners
- Horizontal members use a Shear Block to method to fasten horizontal and vertical members
- Painted Finishes in Standard and Custom Colors to AAMA 2605 Superior Performance Coating.
- Optional Features:
  - Reinforce Mullions for greater Spans;
  - Rainscreen Panel and Back Pan;
  - Optional deep profile or Bullnose covers;
  - Heavy Weight Mullions;
- Product Applications:
  - Low or Mid-Rise Buildings
  - Health Care Facilities
  - Educational Facilities
  - Retail
  - Parking Garages

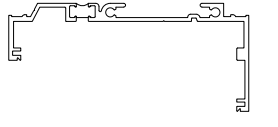
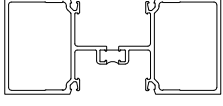
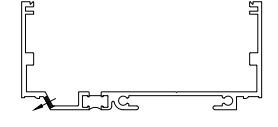
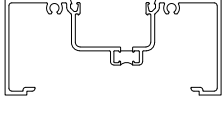
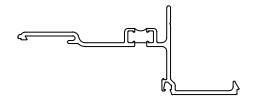
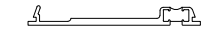
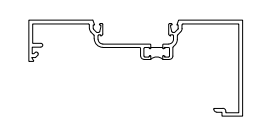
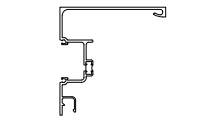
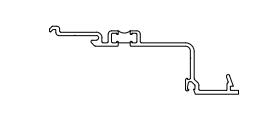
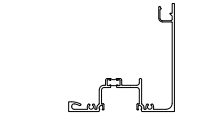
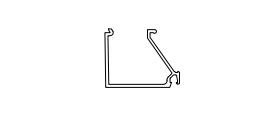
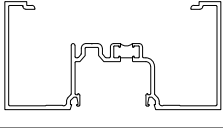
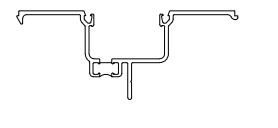
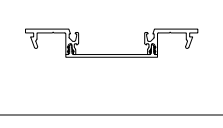
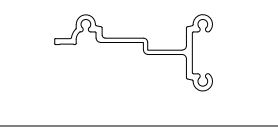
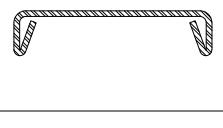
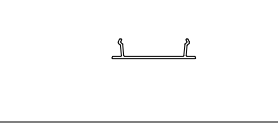
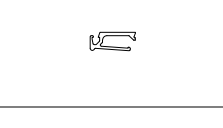
### System Parts - Typical Parts

Part #	Description	Image	Part #	Description	Image
150101	Head Receptor		150201	Mullion	
150102	Sill Receptor		150202	Jamb Mullion	
150103	Head		150203	Jamb Mullion Filler	
150104	Intermediate Horizontal		150204	Corner Mullion Part A	
150105	Intermediate Horizontal Closure		150205	Corner Mullion Part B	
150106	Glass Stop		150206	Reinforced Mullion	
150107	Sill		150207	Reinforced Mullion Filler	
150301	Shear Block		150208	Steel Reinforcement	
150302	Pocket Filler		150303	1/8" to 3/8" Glazing Adapter	
			150304	1/2" to 5/8" Glazing Adapter	

### Outside Glaze

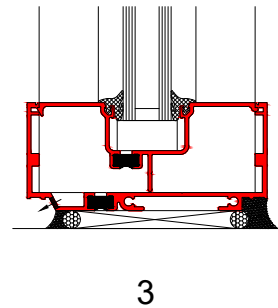
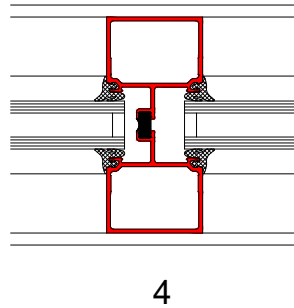
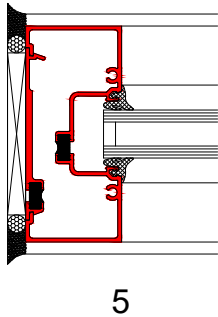
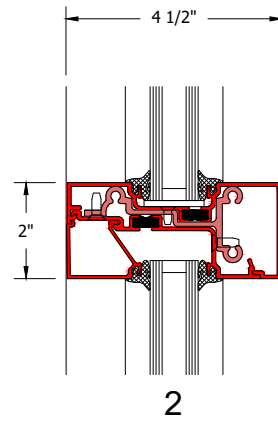
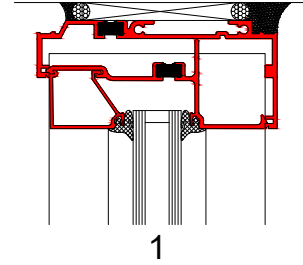
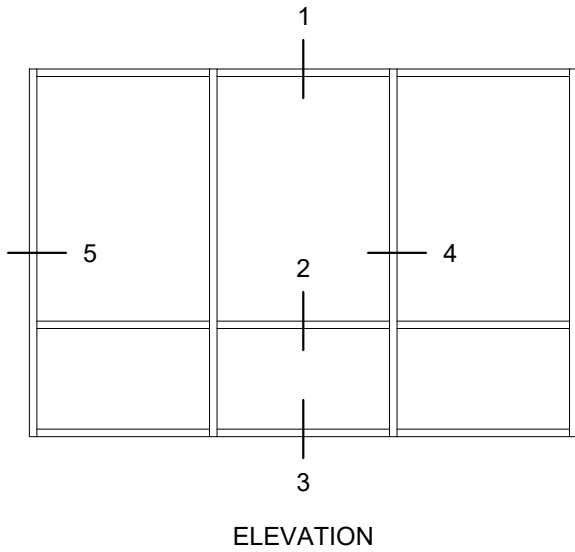

### Inside Glaze

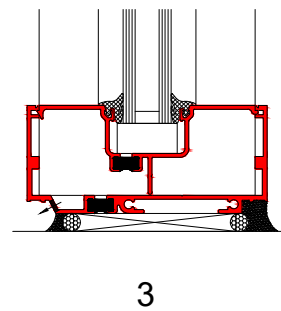
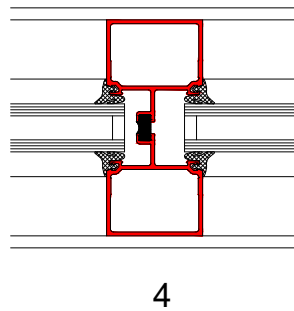
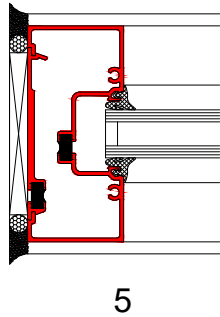
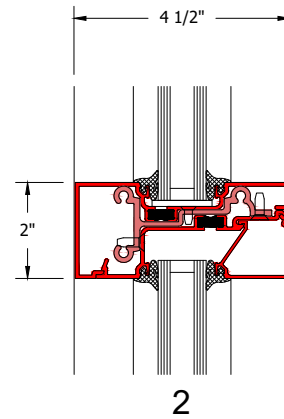
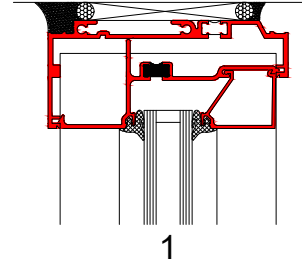
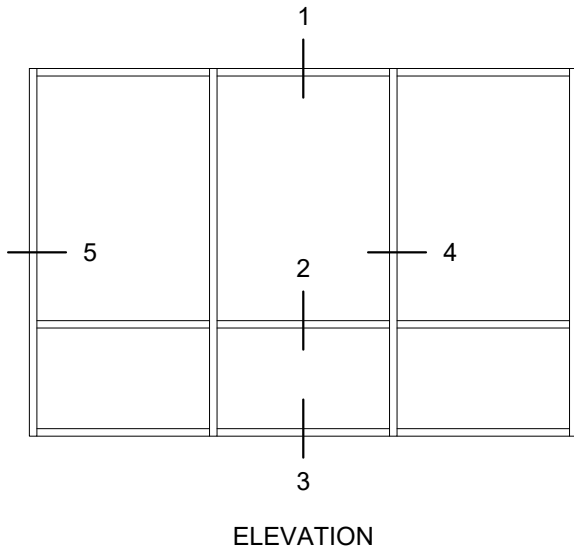

### Vents

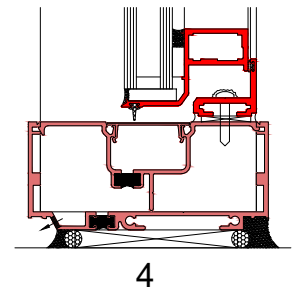
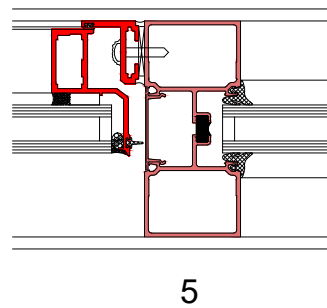
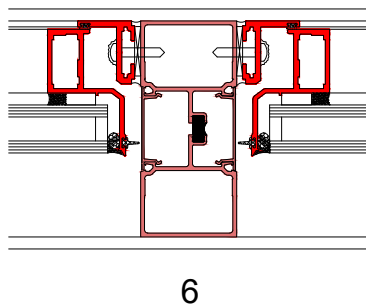
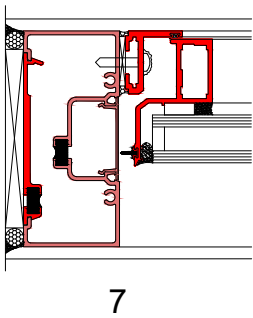
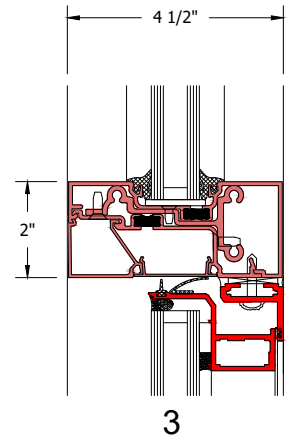
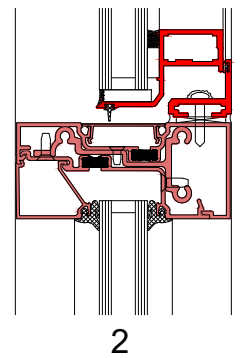
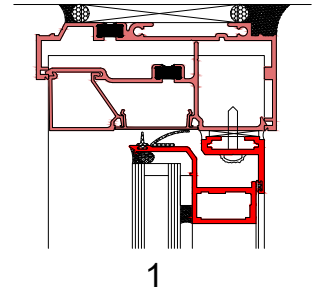
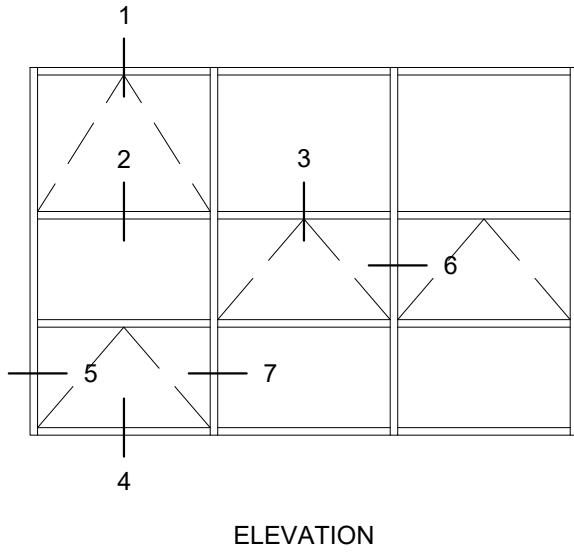

### Infill Options

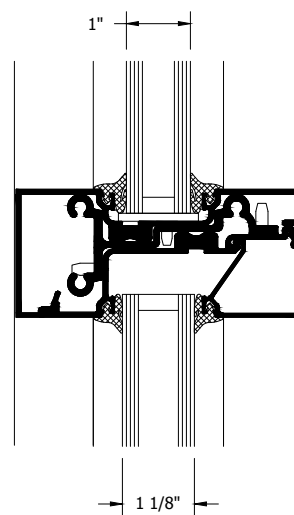
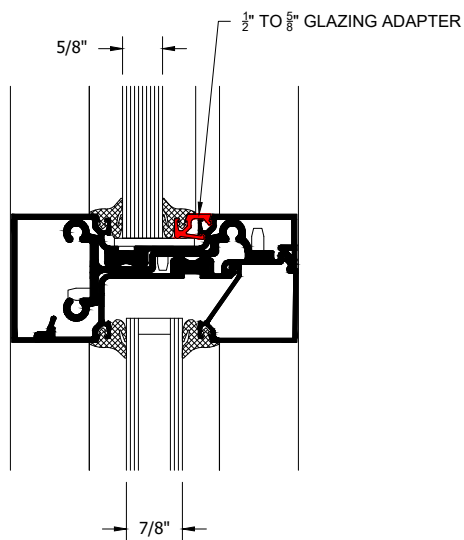
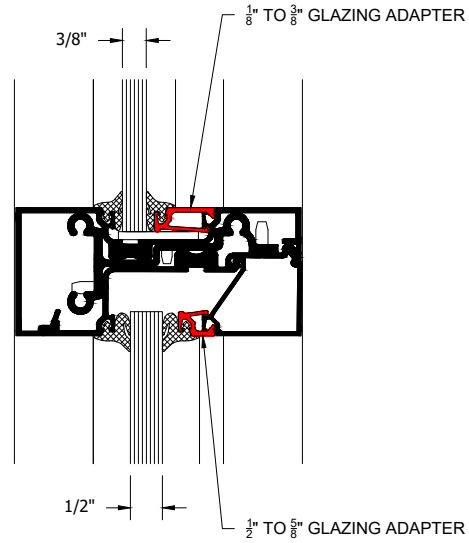
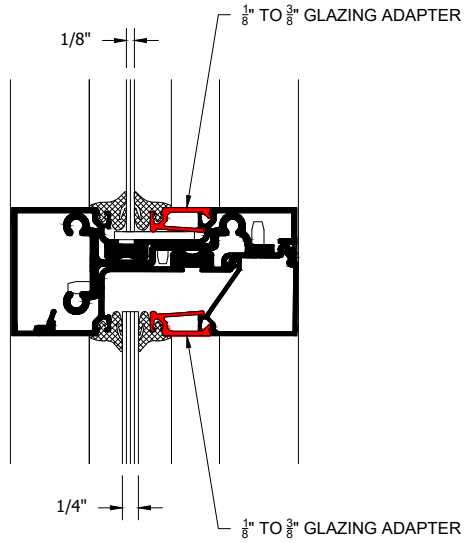

### Entrance Details

Note: Typical door details shown. See door systems for further details

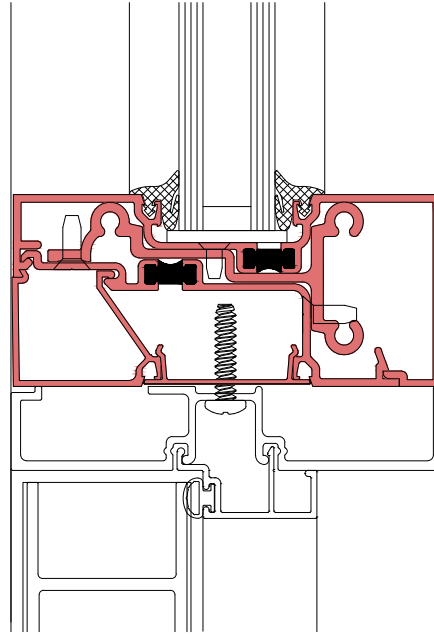

HEAD DETAIL

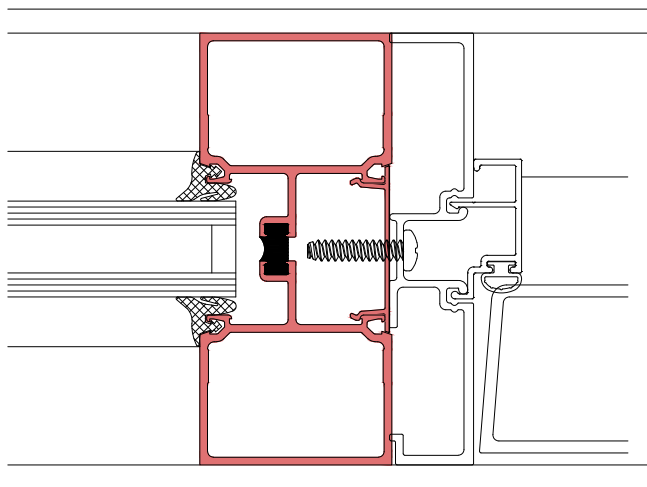

JAMB DETAIL

### Corner Details

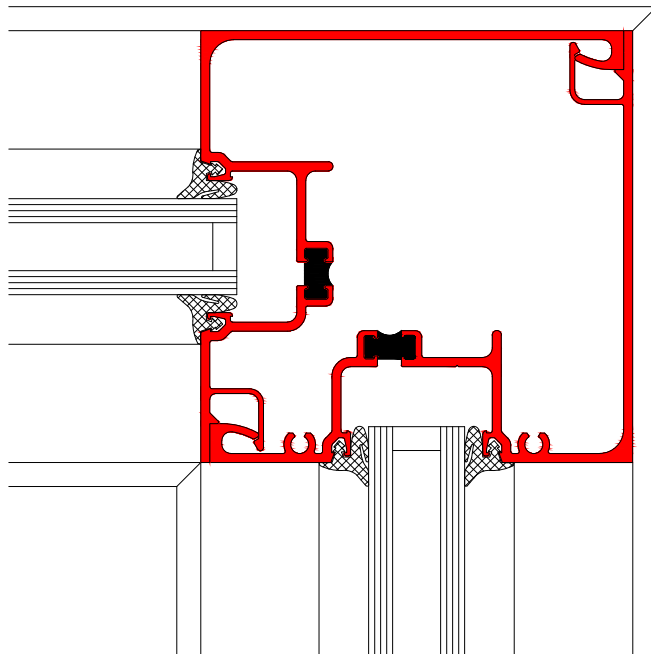

INSIDE CORNER

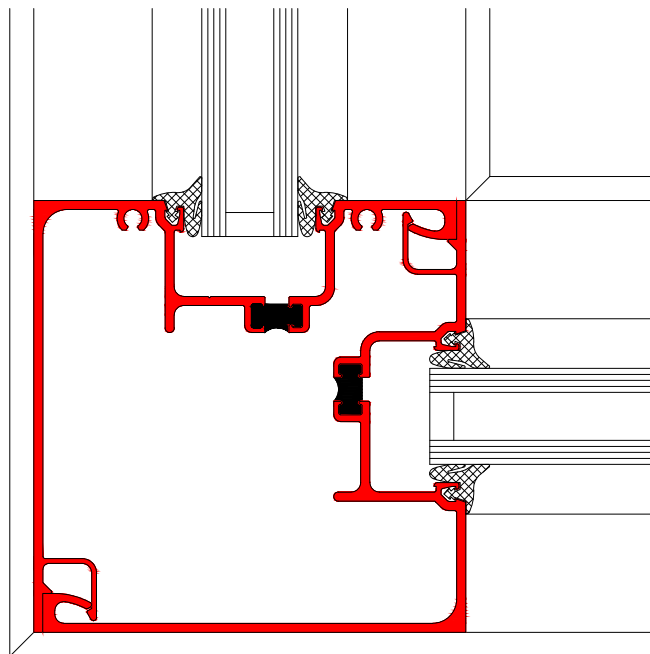

OUTSIDE CORNER